

# Input Power

# Power Supply

The breakout board supports either a high efficiency, wide input range DC/DC or an easy to solder linear regulator. DO NOT POPULATE BOTH.

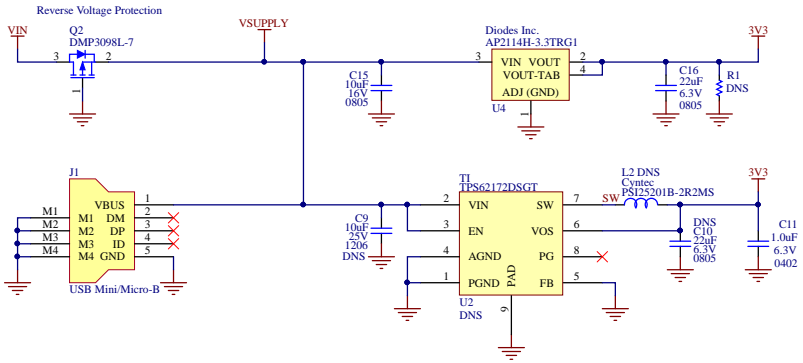

# BlinkUp Phototransistor

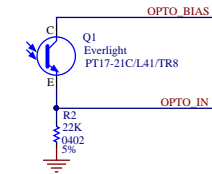

# BlinkUp LED

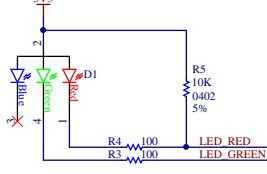

# Breakout Area

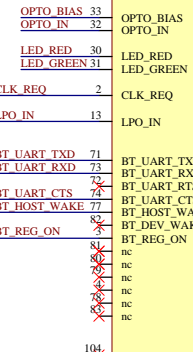
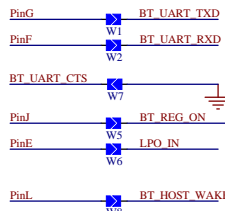
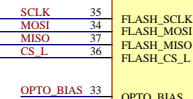
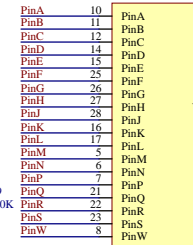
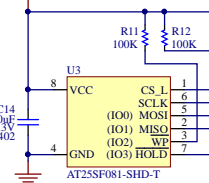
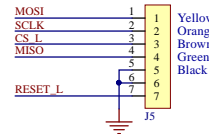
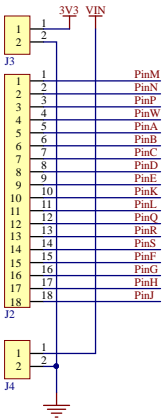

Copyright © 2016, Electric Imp Inc.

Permission is hereby granted, free of charge, to any person obtaining a copy of this work and associated documentation files (the "Work"), to deal in the Work without restriction, including without limitation the rights to use, copy, modify, merge, publish, distribute, sublicense, and/or sell copies of the Work, and to permit persons to whom the Work is furnished to do so, subject to the following conditions:

The above copyright notice and this permission notice shall be included in all copies or substantial portions of the Work.

THE WORK IS PROVIDED "AS IS", WITHOUT WARRANTY OF ANY KIND, EXPRESS OR IMPLIED, INCLUDING BUT NOT LIMITED TO THE WARRANTIES OF MERCHANTABILITY, FITNESS FOR A PARTICULAR PURPOSE AND NONINFRINGEMENT. IN NO EVENT SHALL THE AUTHORS OR COPYRIGHT HOLDERS BE LIABLE FOR ANY CLAIM, DAMAGES OR OTHER LIABILITY, WHETHER IN AN ACTION OF CONTRACT, TORT OR OTHERWISE, ARISING FROM, OUT OF OR IN CONNECTION WITH THE WORK OR THE USE OR OTHER DEALINGS IN THE WORK.

Design: **imp004m breakout** Rev: **5.0**  
 Sheet: 1 of 4 Date: 01/12/2017 Time: 11:13:22  
 File: C:\Users\jagunq\Music\imp004m\imp004m-breakout\_SchDoc

Electric Imp  
 5150 El Camino Real, Ste C-31  
 Los Altos, CA 94022

