

Power Supply

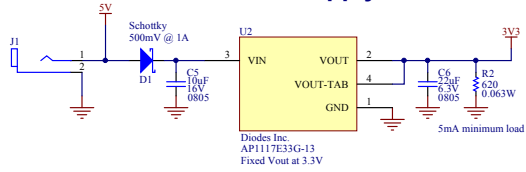

Analog Ambient Light Sensor

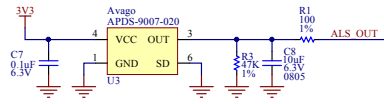

Imp Module

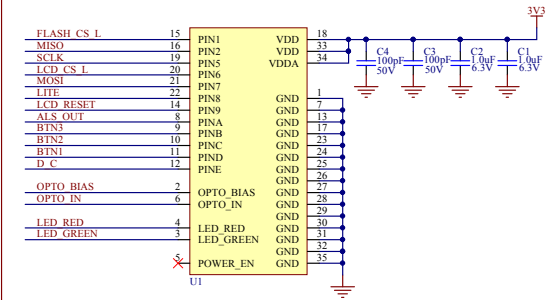

LCD Panel

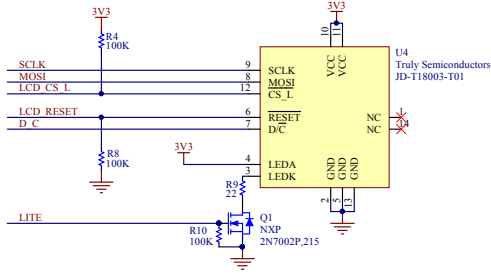

Buttons

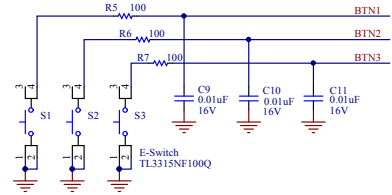

SPI Flash

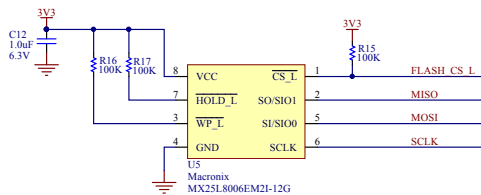

Opto

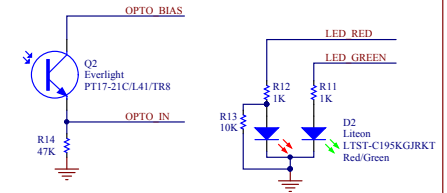

Mounting Screws

